

ANALYSIS OF VAPOUR COMPRESSION REFRIGERATION (VCR) BASED AIR CONDITIONING (AC) SYSTEM FOR HOT AND DRY CLIMATIC CONDITIONS IN OMAN

Muthuraman S.^{1*}, Sivaraj M.²

ABSTRACT

An evaporative-VCR combined AC system for providing good human comfort conditions working under hot & dry climate is proposed in this paper. The system is thermodynamically analysed for hot & dry climate of Muscat, Oman from April-July 2015 under some reasonable assumptions. The system was also compared on the basis of saving in cooling load (%) on the cooling coil for the same sensible cooling rate to the conditioned space from the conventional VCR-AC working on 100 % fresh air assumption. The saving of cooling load on the coil was found maximum (64.19%) in the month of April due to lower outside temperature and minimum (27.36%) for the month of June due to higher outside temperature. The proposed system can be made more energy efficient by utilising the exhaust air in cooling the condenser of VCR system which will improve the COP & hence reduce the power consumption of the compressor.

Keywords: *Evaporative Cooler, VCR System, Cooling Load, Humidifying Efficiency, Conditioned Space*

INTRODUCTION

Air conditioners are becoming basic necessity in every household today. With the global warming increasing the temperature every month, it's not easy to stay indoors without a perfect cooling system. An air conditioner is a major home appliance today across the world to change the temperature & humidity level inside the room. But if not taken care, it can cause serious health issues in the people of all age groups. Conventional vapour compression air condition system operating under hot & dry condition supplies cold & dry air. Studies have shown that dry air has following effects on the human body:

Breathing dry air is a potential health hazard which can cause respiratory ailments such as asthma, bronchitis, and nosebleeds or general dehydration since body fluids are depleted during respiration, Skin moisture evaporation can cause skin irritations and eye itching, When the human body is exposed to the dry air for many years then the synovial fluid of the joints which act as lubricant begin to dry up due to evaporation. This June allow the bones to rub against each other painfully, Arthritis joint pain inflammation is increased more due to blowing of cold and dry air from the air conditioner. Researchers did research on the effect of air conditioning air on arthritis patients. They detected that air conditioner cannot create humid effect in the interior of the room, which makes air dry and thus overall effect makes joint more painful.

These problems can be reduced by simply increasing the indoor relative humidity. Which can be increased by the direct evaporative cooler, but the direct evaporative cooler alone cannot reduce the temperature of the room to human comfort condition.

Hence it is desirable to use direct evaporative cooler in connection with conventional vapour compression air conditioning system which brings the air temperature to the human comfort condition. Nada et al. [1] Theoretical investigated the performance of proposed integrative air conditioning (A/C) and humidification-dehumidification desalination (HDD) systems for the purpose of energy saving of the air conditioning system and at the same time utilizing the system in fresh water production for the large capacity air conditioning systems .Cianfrini et al. [2] Proposed An integrated energy-recovery system basically consisting of an indirect evaporative cooling equipment combined with a cooling/reheating unit to reduce the energy demand of air conditioning installations. Wang et al. [3] investigated the Coefficient of Performance (COP)'s augmentation of an air conditioning system utilizing an

This paper was recommended for publication in revised form by Regional Editor Bekir Yilbas

¹Lecturer, Higher college of Technology, Muscat, Oman.

²Assistant Professor, Hawassa University, Awassa, Ethiopia.,

*E-mail address: muthu9678@gmail.com

Manuscript Received 23 June 2016, Accepted 22 January 2017

evaporative cooling condenser. The experimental facility consisted of four major components, which are, the compressor, the evaporator, the thermal expansion valve, and the condenser. An evaporative cooling unit was located upstream from the condenser.

Thermal parameters, such as relative humidity, dry bulb temperature, and wet bulb temperature were measured to evaluate the effect of in-direct evaporative cooling on the system's COP. Jain et al. [4] studied the financial feasibility of a hybrid mode operation of a direct evaporative Cooler (DEC) with an air conditioning (AC) unit to reduce the annual expenditure on electricity usage (as against standalone AC unit to provide almost similar level of comfort) are presented. Four different building applications located in four different cities of Oman have been considered in the study. The hybrid mode operation is found financially attractive for Movie Theatres and waiting hall building applications for all the climatic conditions considered in the study. Kim et al. [5] studied the energy performance of an indirect and direct evaporative cooler assisted 100% outdoor air system (IDECOAS). It was concluded that the IDECOAS operating in the two-stage mode in the intermediate season shows a 51% energy saving over the conventional VAV system. However, the proposed system June consume 36% more operating energy than the conventional VAV system during the cooling season. This June be caused by limited cooling performance of the IEC in hot and humid climate. Fouda et al. [6] studied the heat and mass transfer, process in direct evaporative cooler. A simplified Mathematical model is developed to describe the heat and mass transfer between air and water in a direct evaporative cooler. The study presents a comparison of the computed results with that of experimental results for the same evaporative cooler. The predicted results show validity of simple mathematical model to design the direct evaporative cooler, and that the direct evaporative cooler with high performance pad material June be well applied for air conditioning systems. Sheng et al. [7]

Studied the Empirical correlation of cooling efficiency and transport phenomena of direct evaporative cooler Effects of three system parameters (speed of frontal air, the dry-bulb temperature of frontal air, and the temperature of the incoming water) on cooling performance were evaluated. Each parameter was varied while holding all other variables constant, and data was collected using several different levels of each parameter. The general relationship between each parameter and efficiency was determined by graphing the data collected and observing trends. Malli et al. [8] investigated the performance of cellulosic evaporative cooling pads. Thermal performance of two types of cellulosic pads (5090 and 7090) which were made from corrugated papers has been studied experimentally. The results show that overall pressure drop and amount of evaporated water increase by increasing the inlet air velocity and thickness in both types of pads.

On the other hand, effectiveness and humidity variation decrease by increasing inlet air velocity. Wu et al. [9] studied the theoretical analysis on heat and mass transfer in a direct evaporative cooler. A simplified cooling efficiency correlation is proposed based on the energy balance analysis of air. The Influences of the air frontal velocity and the thickness of pad module on the cooling efficiency of a direct evaporative cooler are discussed. An optimum frontal velocity of 2.5 m/s is recommended to decide the frontal area of pad module in the given air flow. The simplified correlation of cooling efficiency is validated by the test results of a direct evaporative cooler. Dai & Sumathy [10] studied a cross-flow direct evaporative cooler using honeycomb paper as packing material.

A mathematical model, including the governing equations of liquid film and gas phases as well as the interface conditions, has been developed. Analysis results indicate that there exists an optimum length of the air channel, which results in the lowest temperature, and the system performance can be further improved by optimizing the operation parameters, such as the mass flow rates of feed water and process air, as well as the different dimensions of the honeycomb paper. Ca April go et al. [11] Studied the direct evaporative cooler operating during summer in a Brazilian city developed a mathematical model for direct evaporative cooling system and presented the experimental results of the tests performed in a direct evaporative cooler that took place in the Air Conditioning Laboratory at the University of Taubate Mechanical Engineering Department, located in the city of Taubate, State of Sao Paulo, Brazil. Zhang et al. [12] developed mathematical model to describe the heat and moisture transfer between water and air in a direct evaporative cooler.

The influences of the inlet frontal air velocity, pad thickness, inlet air dry-bulb and wet-bulb temperatures on the cooling efficiency of the evaporative cooler are calculated and analyzed. The predicted results show the direct evaporative cooler with high performance pad material June be well applied for air conditioning with reasonable

choices for the inlet frontal velocity and pad thickness. Kulkarni and Rajput [13] studied about the theoretical performance analysis of cooling pads of different materials for evaporative cooler. The material have been considered, rigid cellulose, corrugated paper, corrugated high density polythene and aspen fibre .It has been observed that the saturation efficiency decreases with increasing mass flow rate of air. It also seen that material with higher wetted surface area gives higher saturation efficiency. The literature review above shows that most of the work has been done on evaporative cooler & vapour compression system separately. No work has been done before to determine the performance of the combined system for the domestic purpose under hot & dry climate. Therefore, the objective of this combined system is necessary & important especially when implementing this system into the real application under hot & dry condition. Looking to the above problems a system is proposed in this paper as shown in Figure 1 which is the combination of direct evaporative cooler & conventional vapour compression air conditioner, which on operating together under hot & dry condition produces cold & humid air to the human comfort condition.

SYSTEM DESCRIPTION

Conventional vapour compression air conditioner as shown in Figure 2 operating under hot & dry condition blows cold & dry air because of the lower relative humidity of the surrounding air. If the surface temperature of the coil is lower than the dew point temperature of surrounding air then the coil acts as a dehumidifying coil which results in further reduction in the humidity of supplied air. This cold & dry air which is responsible for skin & other problems as discussed above is harmful for human being. Looking to the above problem a system is proposed in which the direct evaporative cooler & the vapour compression air conditioner are used in series. Cooling coil is fitted in front of the evaporative cooler but it is not easy to use direct evaporative cooler along with the conventional vapour compression air conditioner due to its lower cooling coil temperature.

Therefore certain modification needs to be done before it is used with the evaporative cooler and increasing the cooling coil temperature to sufficient high value is one of them in order to reduce the dehumidification of air input to the cooling coil. The hot & dry air from the outside is first cooled and humidified in a direct evaporative cooler where it decreases its sensible heat to the water & increases its latent heat by adding moisture into it. The process occur in such a way that the enthalpy of the air before the evaporative cooler is same as enthalpy of the air after the evaporative cooler as shown in Figure 3. This cold & humidified air when blows across the cooling coil further reduces its temperature and retain its maximum moisture due to its higher coil surface temperature as compared to the conventional cooling coil of air conditioner. This air after the cooling coil is supplied to the conditioned space where cooling is required. Again the hot & dry air from the outside is taken by the evaporator & cycle is repeated as shown in Figure.1.

THERMODYNAMIC ANALYSIS ASSUMPTIONS

WBT of the air before & after the evaporative cooler remains constant.

Mass flow rate of air is constant throughout the system.

Outside condition of air is assumed to be hot & dry.

Inside design condition is taken as 25°C & 50% R.H.

The humidifying efficiency of evaporative cooler is taken as 70% irrespective of water.

Bypass factor of the cooling coil is taken as 0.2.

Surface temperature of the cooling coil for proposed system & conventional system is taken as 18°C & 2°C respectively for the calculation.

The circulating pump power of the evaporative cooler & power of the fan is negligible as compared to the power of the air conditioning system.

100 % fresh air is supplied to the room i.e no recirculation of air.

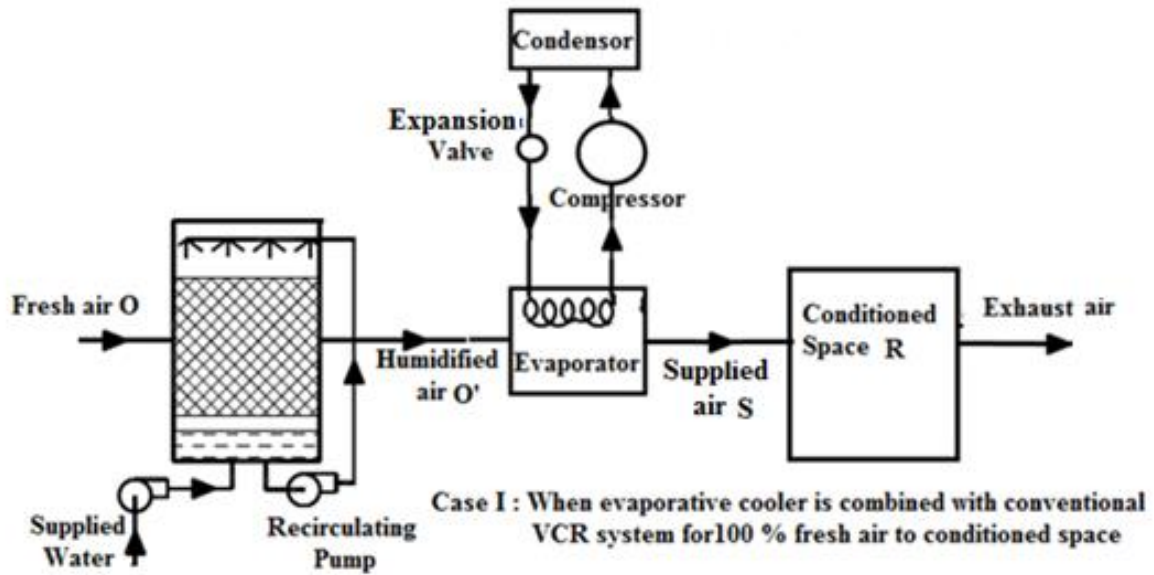

Figure 1. Proposed system for 100 % fresh air to conditioned space

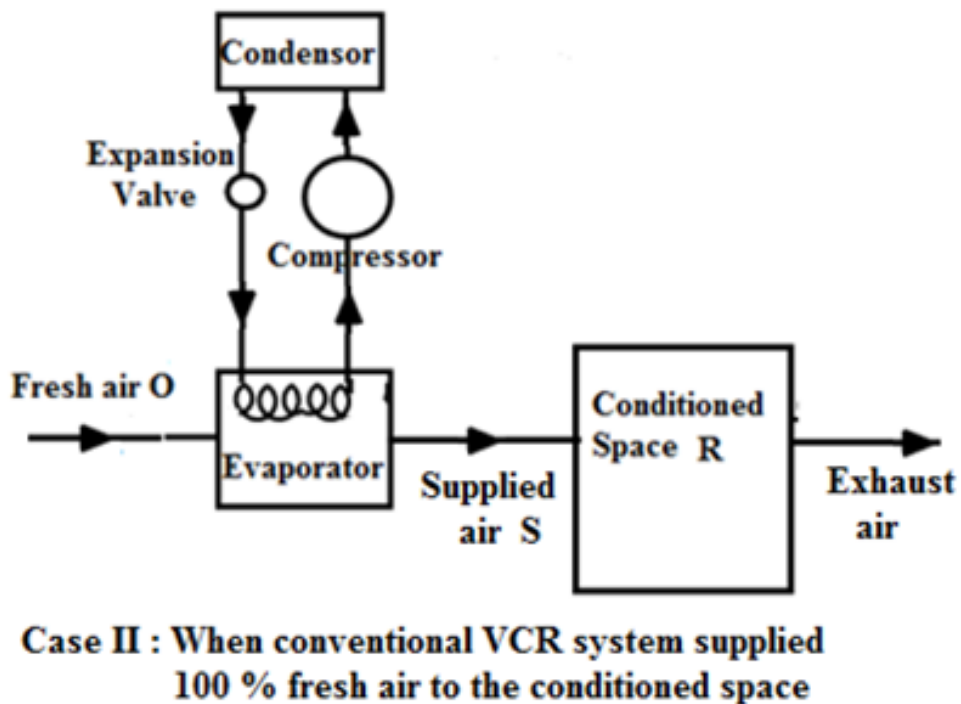

Figure 2. Conventional VCR system for 100 % fresh air to conditioned space

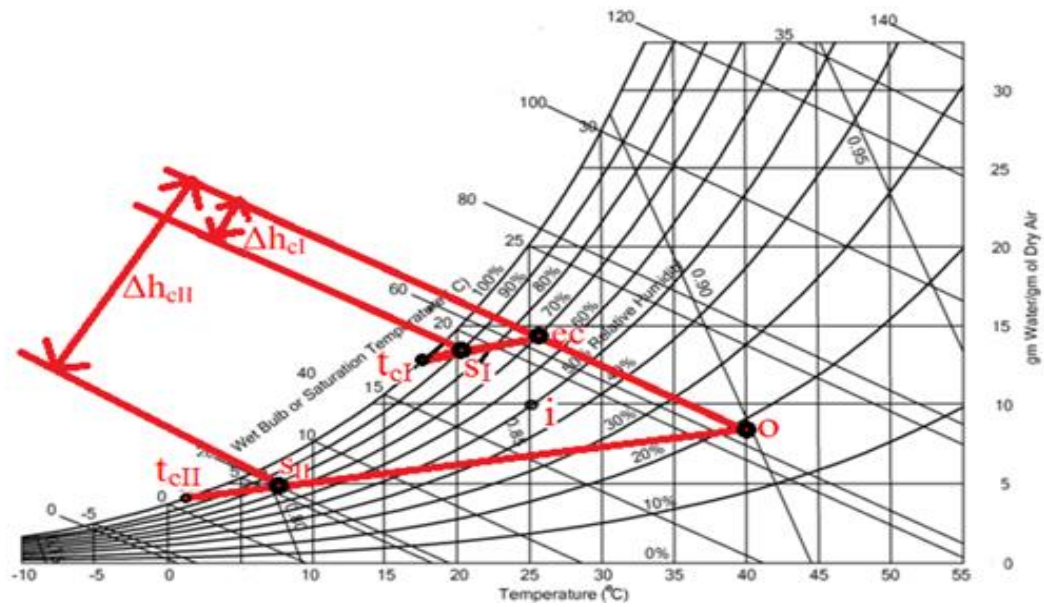

Figure 3. Psychrometric representation of proposed system & conventional system

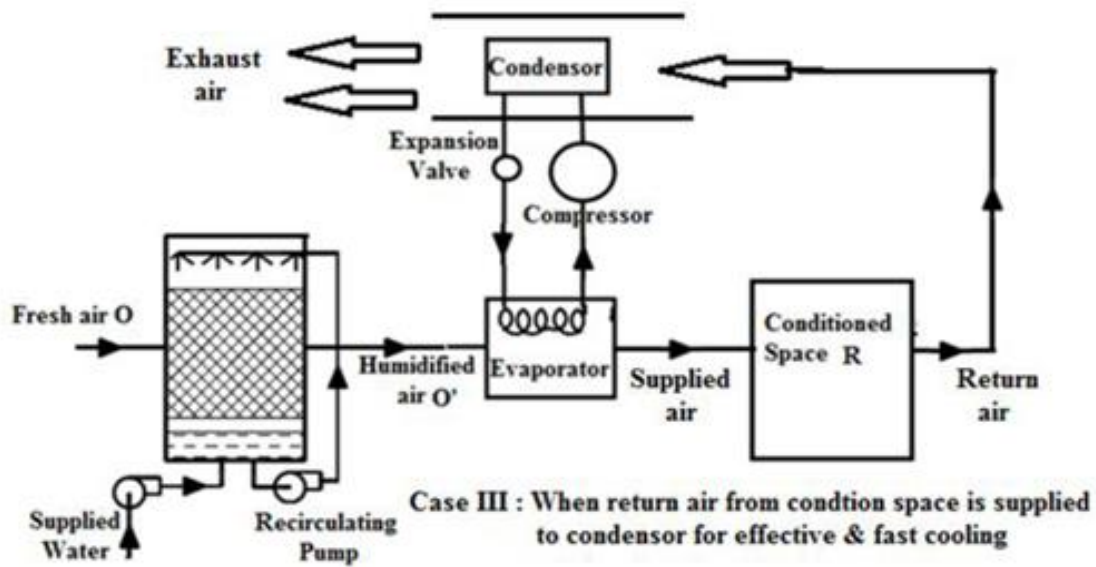

Figure 4. When the proposed system supplies the return air to the condenser of VCR for effective cooling.

THERMODYNAMIC ANALYSIS

Equations

Temperature of air after evaporative cooler in case I,

$$t_{ec} = [t_o - \{(\eta/100) * (t_o - WBT_o)\}] \quad (1)$$

Temperature of Supply air to space in case I i.e in proposed system,

$$t_{sI} = [t_{cI} + \{X * (t_{ec} - t_{cI})\}] \quad (2)$$

Also specific enthalpy is constant across the evaporative cooler, $h_o=h_{ec}$

Specific enthalpy of air supplied to the space in case I,

$$h_{sI}=[h_{cI} + \{X^*(h_{ec}- h_{cI})\}] \quad (3)$$

Cooling Load on the cooling coil in case I,

$$Q_{cI}=m_a^*(h_{ec}-h_{sI}) \quad (4)$$

Sensible cooling rate to the conditioned space in case I,

$$Q_{sI}=m_a^*(1.005+ \omega_{sI}^*1.88)^*(t_{sI}-t_i) \quad (5)$$

Where t_i is same in both the cases

Supply temperature of air in case II i.e in conventional system

$$t_{sII}= [t_{cII} + \{X^*(t_o- t_{cII})\}] \quad (6)$$

Specific enthalpy of air supplied to the space in case II,

$$h_{sII}=[h_{cII} + \{X^*(h_o- h_{cII})\}] \quad (7)$$

Cooling Load on the cooling coil in case II,

$$Q_{cII}=m_a^*(h_o-h_{sII}), \text{ where } h_o \text{ is same in both cases} \quad (8)$$

Sensible cooling rate to the conditioned space in case II,

$$Q_{sII}=m_a^*(1.005+ \omega_{sII}^*1.88)^*(t_{sII}-t_i) \quad (9)$$

Saving of cooling load on the cooling coil for same sensible cooling rate saving in

$$Q_c (\%) = [\{ (Q_{cII}- Q_{cI}) / Q_{cI} \} * 100] \quad (10)$$

METHODOLOGY

The theoretical analysis of the proposed system is done for hot & dry climate of Muscat, Oman. The weather data for the four months from April-July 2015 is collected from Oman meteorological department, Muscat [14]. The average outside dry bulb temperature of air for different months is taken as the average of daily maximum of that month as shown in table 1 & Figure 5 (a-b). Similarly the average outside relative humidity of air is also taken as the average of daily minimum of that month. Elevation of Muscat is taken as 523 m for calculation.

Table 1. Weather conditions for different months

S. No	Month	Outside DBT (° C)	Outside R.H (%)
1	April	33.9	24
2	May	37.8	24.7
3	June	42	17
4	July	38.5	40

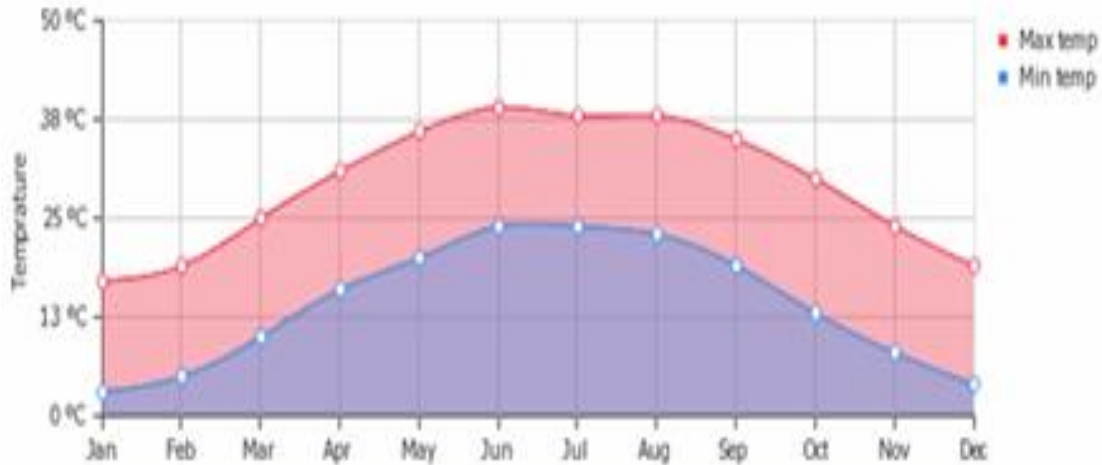

Figure 5(a). Temperature conditions for different months in Oman

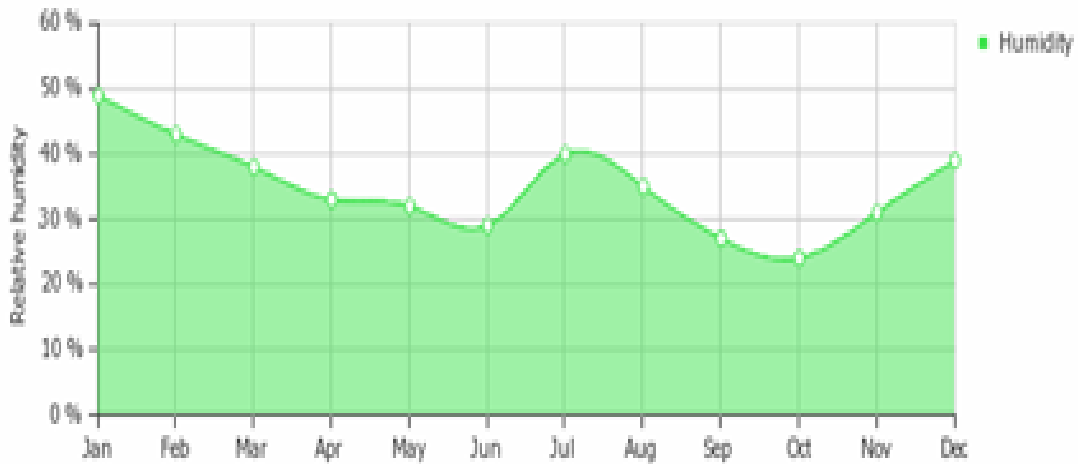

Figure 5(b). Humidity conditions for different months in Oman

Calculation is performed on the excel solver for four months of Muscat. Proposed system is also compared from the conventional system as shown in Figure.5 on the basis of cooling load on the cooling coil for the same sensible cooling rate obtained by varying the mass flow rate of air keeping the other parameters fixed.

RESULTS & DISCUSSIONS

Variation of saving in cooling load Q_c (%) on the cooling coil in the proposed system as compared to the conventional system for the same sensible cooling rate Q_{sr} in the conditioned space w.r.t. four months is shown in Figure.6. Significant saving in the load on the cooling coil can be seen from Figure 6 & in table 2. Load saving on the cooling coil is decreasing from the month of April to the month of July with a maximum of 64.19% & minimum of -51.21% in the April & July respectively. Load saving in the month of April is maximum because of lower surrounding temperature and is negative in the month of July because of higher relative humidity of the air resulting in high latent load on the cooling coil. Negative sign indicates that the proposed system is not feasible for the month of July while it is working reasonably well from April to June.

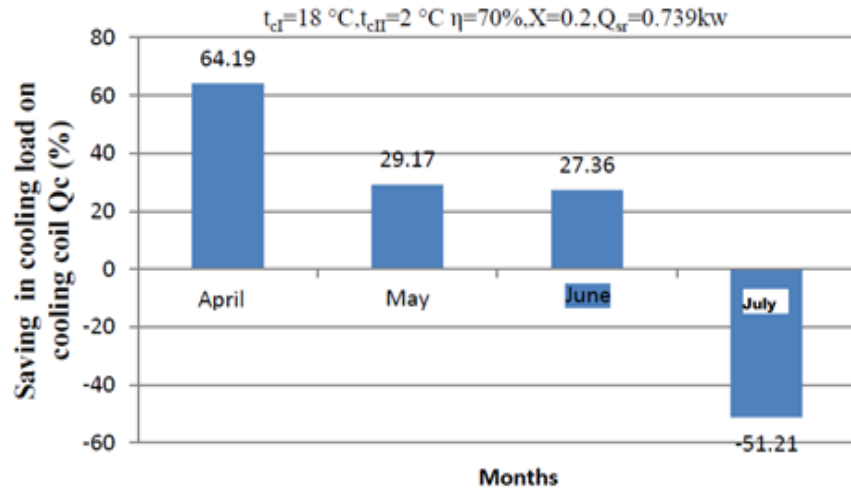

Figure 6. Variation of saving in cooling load on the cooling coil w.r.t. months in the proposed system as compared to the conventional system for 100 % fresh air to conditioned space.

Table 2. Comparison of proposed system from conventional system for same sensible cooling rate

S. No	Month	t_{cI} ($^{\circ}\text{C}$)	t_{cII} ($^{\circ}\text{C}$)	Q_{cI} (kJ/s)	m_{aI} (kg/s)	Q_{cII} (kJ/s)	m_{aII} (kg/s)	Q_{sr} (kJ/s)	Q_c (%)
1	April	18	2	1.44	0.330	4.04	0.120	0.739	64.19
2	May	18	2	3.54	0.349	5.00	0.120	0.667	29.17
3	June	18	2	3.66	0.35	5.04	0.120	0.63	27.36
4	July	18	2	10.51	0.398	6.95	0.120	0.581	-51.21

Variation of cooling load (Q_c) on the cooling coil at the same sensible cooling rate (Q_{sr}) of 2.03 kw for the four months w.r.t coil surface temperature of the conventional system is shown in the Figure.6. Cooling load (Q_c) on the coil is increasing with increasing the coil surface temperature (t_{cII}) due to decreasing the sensible cooling rate to the conditioned space & hence in order to equalise the sensible cooling rate, the mass flow rate of air (m_a) is increasing which increases the cooling load on the coil keeping the other parameters fixed. Cooling load on the coil is minimum with a value of 4.03 kw for the month of April and it is maximum with a value of 11.54 kw for the month of July. It is increasing from April to July due to increasing the enthalpy of air supplied to the cooling coil.

Variation of cooling load Q_c on the cooling coil in the proposed system for the same sensible cooling rate Q_{sr} of 0.774 KW to the conditioned space w.r.t. the humidifying efficiency (η) of the evaporative cooler for the four months can be seen from Figure 8 The load on the cooling coil decreases with increasing the humidifying efficiency (η) of the evaporative cooler with a maximum value of 0.74KW, 1.5KW, 1.67KW, 4.49KW at humidifying efficiency of 60% & a minimum value of 0.37KW, 1.34KW, 1.42KW, 4.04KW at humidifying efficiency (η) of 80% from the month of April to the month of July respectively because of decreasing the temperature of air after the evaporative cooler or supply temperature to the cooling coil Cooling load on the coil (Q_c) increases from April to

June with a minimum of 0.37KW at 80% humidifying efficiency & maximum of 1.67 KW at humidifying efficiency of 60 % respectively.

Variation of cooling load Q_c on the cooling coil in the proposed system for the same sensible cooling rate Q_{sr} of 0.8 KW to the conditioned space w.r.t. the bypass factor (X) of the cooling coil for the four months can be seen from Figure.9 The load on the cooling coil increases with increasing the bypass factor (X) of the cooling coil with a minimum value of 0.59 KW, 1.43 KW, 1.50 KW, 3.87 KW at bypass factor (X) of 0.1 & a maximum value of 0.59 KW, 1.53 KW, 1.73 KW, 5.09 KW at bypass factor (X) of 0.3 from the month of April to the month of July respectively. The slope of the line is increasing from April to July due to increasing the specific enthalpy of the air supplied to the coil but slope for the month of April is almost zero because the air is cooling sensibly in the cooling coil due to lower dew point temperature of air after the evaporative cooler or before supplying to the coil compared to the coil surface temperature. Cooling load on the coil (Q_c) increases from April to July with a minimum of 0.59 KW at bypass factor (X) of 0.1 & maximum of 5.09 KW at bypass factor (X) of 0.3 respectively.

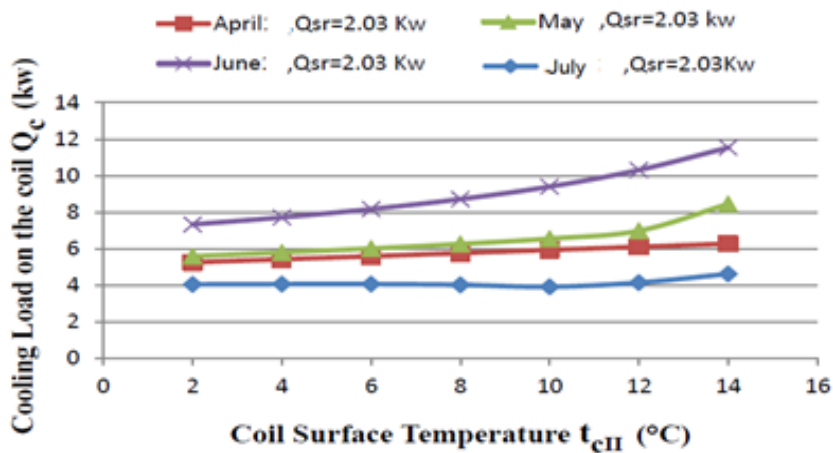

Figure 7. Variation of cooling Load on the cooling coil w.r.t. the coil surface temperature in the conventional system

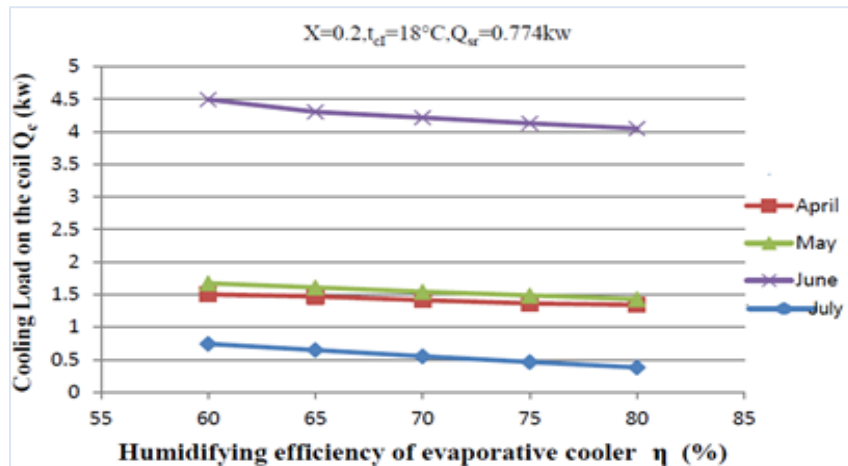

Figure 8. Variation of cooling load on the cooling coil w.r.t humidifying efficiency in the proposed system

Variation of mass flow rate (\dot{m}_a) of supply air to the conditioned space w.r.t. four months for the same sensible cooling rate (Q_{sr}) of 0.739 KW is shown in Figure.10 The mass flow rate (\dot{m}_a) is increasing from April to July from 0.12 kg s^{-1} to 0.15 kg s^{-1} respectively because of increasing the enthalpy h_a of surrounding air from 55.76 kJ Kg^{-1} to 86.1 kJ Kg^{-1} respectively.

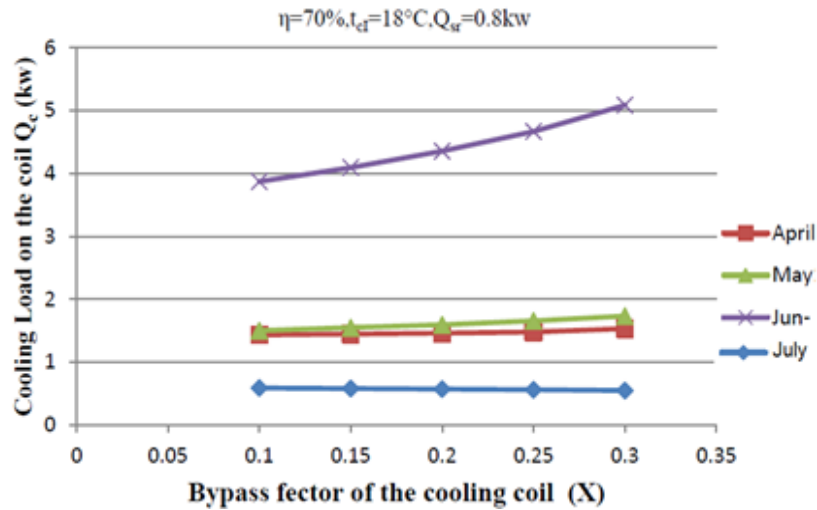

Figure 9. Variation of cooling load on the coil w.r.t. Bypass factor of proposed system.

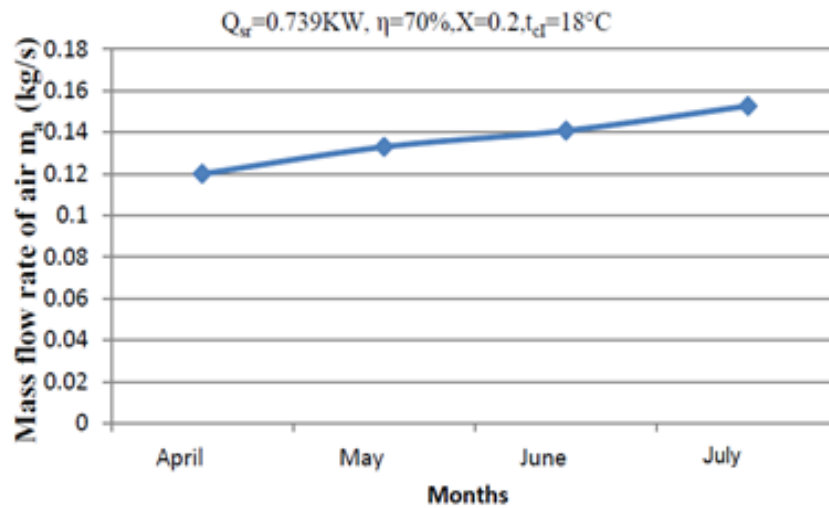

Figure 10. Variation of mass flow rate of supply air to the room w.r.t. months in the proposed system

Variation in the temperature of supply air (t_a) to the conditioned space w.r.t. the humidifying efficiency (η) of the evaporative cooler is shown on Figure. 11 The temperature (t_a) is decreasing with increasing the humidifying efficiency from a value of $19.4 \text{ }^\circ\text{C}$ to $18.8 \text{ }^\circ\text{C}$, $20.0 \text{ }^\circ\text{C}$ to $19.4 \text{ }^\circ\text{C}$, $20.4 \text{ }^\circ\text{C}$ to $19.6 \text{ }^\circ\text{C}$ & $20.6 \text{ }^\circ\text{C}$ to $20.1 \text{ }^\circ\text{C}$ at a humidifying efficiency (η) of 60% to 80% for the month from April to July respectively. Variation of cooling load (Q_c) on the cooling coil for the same sensible cooling rate (Q_{sr}) of 0.739 KW to the conditioned space w.r.t. four months can be seen from Figure.11 & in table 3. The load on the coil (Q_c) is increasing from April to July with a minimum cooling load (Q_c) of 0.525 KW to maximum of 4.02 KW in the month of April & July respectively.

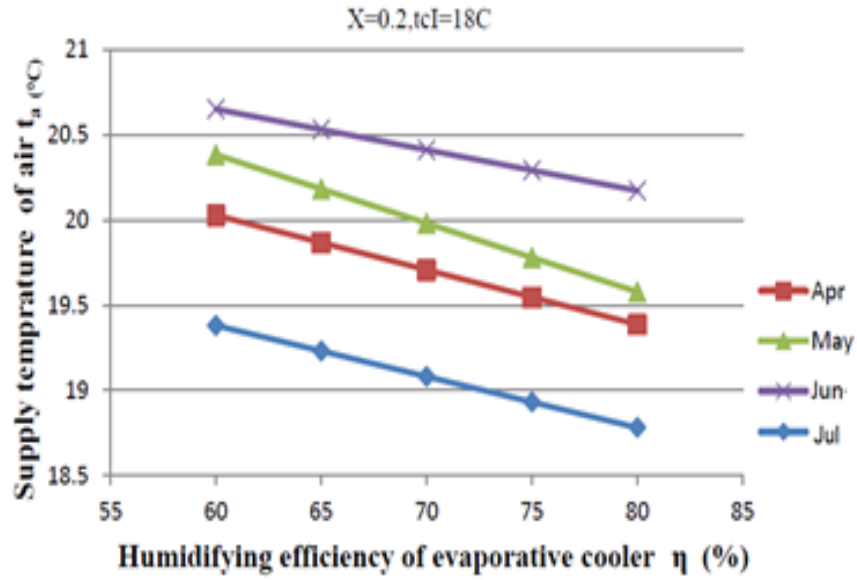

Figure 11. Variation of supply temperature to the room w.r.t. humidifying efficiency in the proposed system

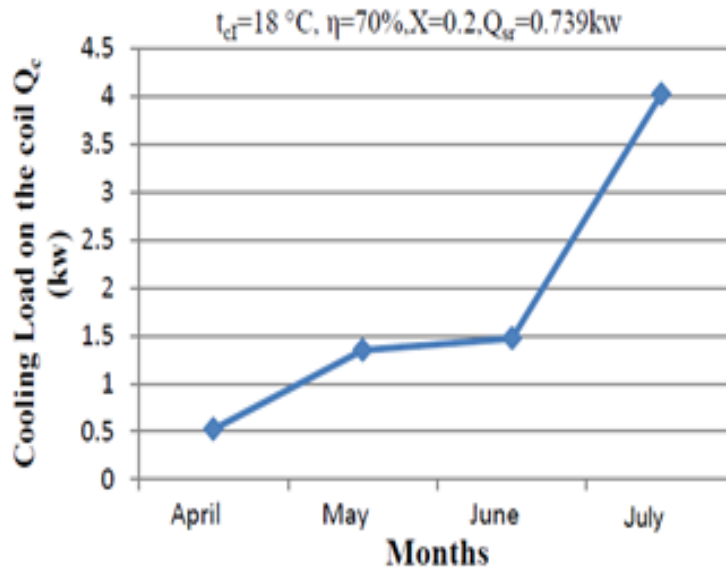

Figure 12. Variation of cooling load on the cooling coil w.r.t. months in the proposed system

Table 3. Comparison of cooling load based on month in proposed system

S. No	Month	t_{ci} (°C)	η (%)	X	m_{aI} (kg/s)	Q_{sr} (kJ/s)	Q_{cI} (kJ/s)
1	April	18	70	0.2	0.120	0.739	0.525
2	May	18	70	0.2	0.132	0.739	1.350
3	June	18	70	0.2	0.140	0.739	1.474
4	July	18	70	0.2	0.152	0.739	4.023

CONCLUSION

The proposed system is theoretically analysed for hot & dry climate of Muscat, Oman under some reasonable assumptions. Analysis is done for the data of April-July 2015. The proposed system was also compared on the basis of saving (%) in cooling load on the cooling coil for the same sensible cooling rate to the conditioned space from the conventional vapour compression air conditioner working on 100 % fresh air assumption. The saving of cooling load on the coil was maximum with a value of 64.19 % in the month of April due to lower outside temperature and it is minimum for the month of June with a value of 27.36 % due to higher outside temperature. Saving in the month of July is -51.21% due to higher relative humidity. Negative sign indicates that proposed system is only for hot & dry climate & worked well from April-June.

The proposed system was also compared on the various parameters with following conclusions.

The cooling load on the cooling coil decreases with increasing the humidifying efficiency of the evaporative cooler for the same sensible cooling rate to the conditioned space. It is minimum for the month of April & maximum for the month of July. The performance of the proposed system can further be increased if it will operate at a place which is drier than Muscat.

Mass flow rate of air supplied to the conditioned room increases from April to July for the same sensible cooling rate due to increasing the specific enthalpy of outside air. Temperature of air supplied to conditioned space decreases with increasing the humidifying efficiency of the evaporative cooler.

Cooling load on the cooling coil increases from April to July due to increase in specific enthalpy of outside air for the same sensible cooling rate. Cooling load on the coil is calculated at humidifying efficiency of 70 % but this load can further be decreased by increasing the efficiency of evaporative cooler up to 85% through the effective cooling pad technology as explained by Kulkarni et al. [13].

The proposed system can be made more energy efficient by utilising the exhaust air in cooling the condenser of VCR system which will improve the COP & hence reduce the power consumption of the compressor as shown in Figure.4 & explained by Wanga et al. [3].

NOMENCLATURE

t	Dry bulb temperature, °C
ϕ	Relative humidity, %
h	specific enthalpy of air, kJ kg ⁻¹
X	Bypass factor of the cooling coil
DPT	Dew point temperature, °C
WBT	Wet bulb temperature, °C
DBT	Dry bulb temperature, °C
VCR	Vapour compression refrigeration
Δh	Change in enthalpy, kJ kg ⁻¹
m_a	Mass flow rate of air kg s ⁻¹
Q	Cooling load, kW
Q_{sr}	Sensible cooling rate to the room, kW
η	humidifying efficiency of evaporative cooler, %
ω	Specific humidity of air, kg/kg of dry air
i	Inside design condition of room
o	Outside condition
c	Cooling coil
ec	condition of air after evaporative cooler
I	Proposed system
II	Conventional system
s	supply condition of air to the room
Sens	Sensible rate

REFERENCES

- [1] S.A. Nada , H.F. Elattar, A. Fouda.(2015) Performance analysis of proposed hybrid air conditioning and humidification–dehumidification systems for energy saving and water production in hot and dry climatic regions. *Energy conversion and Management*; 9(6),208-227.
- [2] Claudio Cianfrini, Massimo Corcione, Emanuele Habib, Alessandro Quintino.(2014) Energy performance of air-conditioning systems using an indirect evaporative cooling combined with a cooling/reheating treatment. *Energy and Buildings* 69(1),490-497.
- [3] Tianwei Wanga, Chenguang Sheng^{a,b}, A.G. Agwu Nnanna (2014). Experimental investigation of air conditioning system using evaporative cooling condenser. *Energy and Buildings* 81(2),435-443.
- [4] Varun Jain, S.C. Mullick, Tara C. Kandpal (2015). A financial feasibility evaluation of using evaporative cooling with air-conditioning (in hybrid mode) in commercial buildings in Oman. *Energy for sustainable development*. 17(2),47-53.
- [5] Min-Hwi Kim, Jae-Weon Jeong.(2015) Cooling performance of a 100% outdoor air system integrated with indirect and direct evaporative coolers. *Energy*.5(2),245-257.
- [6] A. Fouda a, Z. Melikyan.(2015). A simplified model for analysis of heat and mass transfer in a direct evaporative cooler.*Applied Thermal Engineering* 3(1),932-936.
- [7] Chenguang Sheng , A.G. Agwu Nnanna. (2012) Empirical correlation of cooling efficiency and transport phenomena of direct evaporative cooler. *Applied Thermal Engineering* 40(2),48-55.
- [8] Abdollah Malli , Hamid Reza Seyf , Mohammad Layeghi , Seyedmehdi Sharifian , Hamid Behravesh. (2011) Investigating the performance of cellulosic evaporative cooling pads. *Energy and Buildings*; 5(2):2598-2603.
- [9] J.M. Wua, X. Huang, H. Zhang. (2009) Theoretical analysis on heat and mass transfer in a direct evaporative cooler. *Applied Thermal Engineering* .2(9):980-984.
- [10] Y.J. Dai, K. Sumathy. (2002) Theoretical study on a cross-flow direct evaporative cooler using honeycomb paper as packing material. *Applied Thermal Engineering* 2(2):1417-1430.
- [11] Jose Rui CaAprilgoa, Carlos Daniel Ebinumab, Jose Luz Silveira (2005). Experimental performance of a direct evaporative cooler operating during summer in a Brazilian city. *International journal of refrigeration* 2(8):1124-1132.
- [12] J.M. Wu, X. Huang b, H. Zhang.(2009) Numerical investigation on the heat and mass transfer in a direct evaporative cooler. *Applied Thermal Engineering*; 2(9),195-201.
- [13] R.K.Kulkarni, S.P.S.Rajput.(2008). Comparative performance of evaporating cooling pads of alternative materials. *International journal of advanced engineering science and technology*. 10(2),239-244.